

Data Sheet



Article number: 025848460038

Description: Norma Connect pipe coupling
COMBI GRIP GL W2 Ø38,0/40 NBR 16 bar

Measures

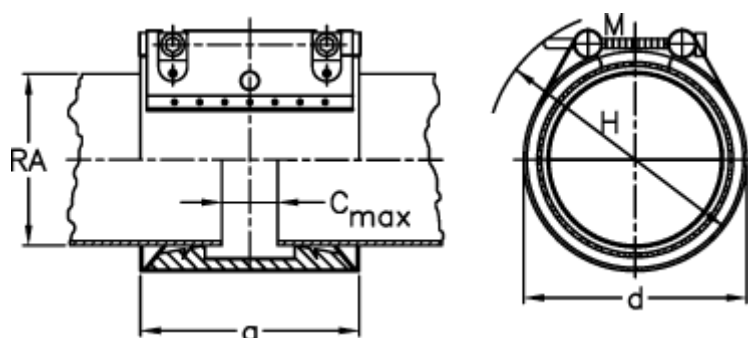

a	= 62.4	RA min-RA max plastic = 39,5-40,5
C max with insertion band	= 8	Weight a piece = 0.6
d	= 60	
H	= 80	
M (screw)	= M8	
Nominal pressure (bar)	= 16	
RA	= 38,0/40,0	
RA min-RA max metal	= 37,5-39,0	